



11EER J18HB-J36HB Series WALL-MOUNT™

The Solair Wall-Mount Heat Pump is a self contained energy efficient heating and cooling system, which is designed to offer maximum indoor comfort at a minimal cost without using valuable indoor floor space or outside ground space. This unit is the ideal product for versatile applications such as: new construction, modular offices, school modernization, telecommunication structures, portable structures or correctional facilities. Factory or field installed accessories are available to meet specific job requirements.

- Complies with efficiency requirements of ASHRAE/IESNA 90.1-2016
- Certified to ASNI/ARI Standard 390-2003 for SPVU (Single Package Vertical Units)
- Intertek ETL Listed to Standard for Safety Heating and Cooling Equipment ANSI/UL 1995/CSA 22.2 No. 236-05 Fourth Edition
- Commercial Product - Not intended for residential application
- Solair is an ISO 9001:2015 Certified Manufacturer



///// WALL-MOUNT NOMENCLATURE

J 3 6 H B - A 0 Z X P X X X X

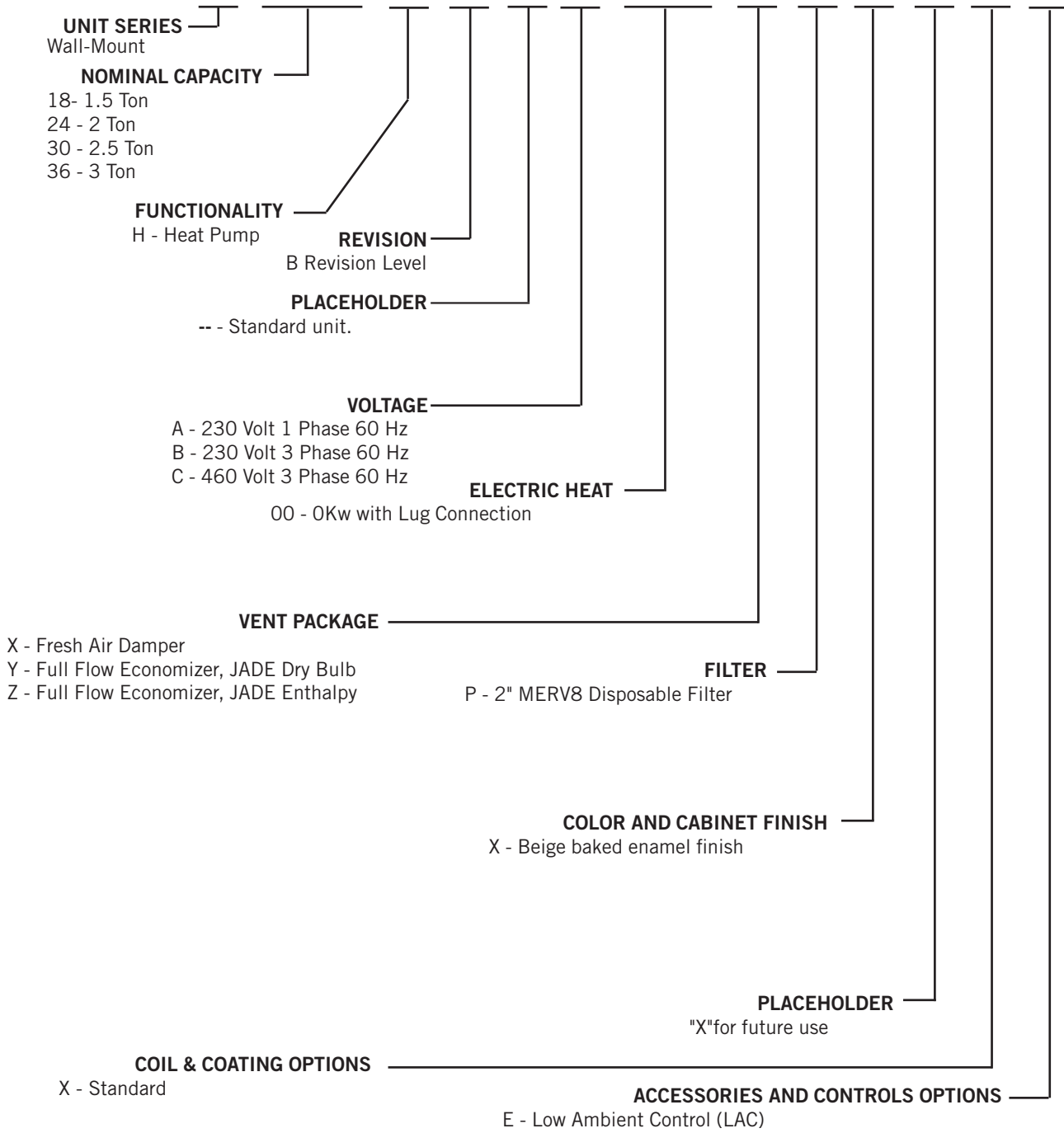

*L - Low ampacity models inhibit concurrent compressor and electric heat operation which results in a lower ampacity requirement. Not recommended for normal use due to lower heating btu capability and no electric heat usage during defrost mode. Feature available with dehumidification models only. Additional order processing time may apply.

ENGINEERED FEATURES

NEW! EXCLUSIVE *Non-Fiberglass Foil Faced Insulation: Environmentally friendly high “R” value non-fiberglass insulation that is made with recycled denim and cotton materials used with a FSK foil face that is both durable and cleanable.

Durable Cabinet Construction: Multiple cabinet construction options are available for different outdoor conditions. Optional cabinet coatings may be ordered for extreme outdoor environments.

Easy Filter Access: A separate filter door is provided for ease of filter access during routine unit maintenance. 1” and 2” filters are available with a rating of up to MERV13.

Field or Factory Installed Vents: Multiple ventilation options are available as easily installed kits with electrical plugs, or Factory installed options that can be removed for service.

Electric Strip Heat: Reliable, comfortable heater packages feature an automatic limit and thermal cut-off safety control. Heater packages can be factory or field installed.

Reliable, Easy-to-Use Controls: Easily accessible through right control panel locations. A lockable hinged access cover to circuit protection is provided. Phase rotation monitor is standard on all 3 phase models. Adjustable compressor on/off delay timer (CCM) with diagnostic lights is standard on all models.

Green Fin Hydrophilic Evaporator Coil: Green fin stock enhances coil wettability to help prevent mold growth, aid with condensate drainage, and provide a limited amount of protection to corrosive particulates in the airstream.

***Balanced Climate™ Technology (patent pending):** High latent capacity humidity & sound reduction removes up to 35% more humidity than any other on the market with the use of a 2 stage thermostat or controlling device. Bard Balanced Climate™ innovation comes standard on all models.

ECM Indoor Brushless DC Motor Technology: 5 speed dual shaft motor provides quiet airflow operation when used with a twin blower assembly. Motor overload protection standard on all models.

Enclosed Condenser Motor: An enclosed casing condenser motor with ball bearings is used for reliable operation and extended motor life. Enclosed condenser motors are standard on all units.

High Efficiency Cooling: Scroll compressors for quiet, efficient cooling. Designed with R-410A (HFC) non-ozone depleting refrigerant in compliance with the Montreal protocol and 2010 EPA requirements. A liquid line filter-drier to protect the system from moisture is standard on all units.

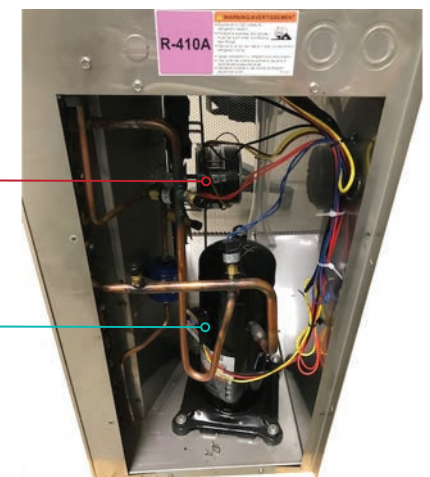
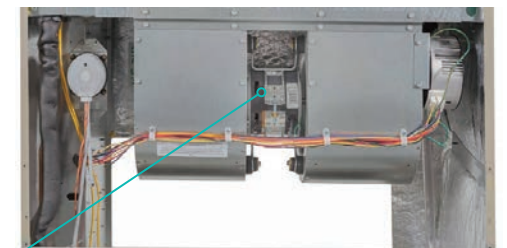
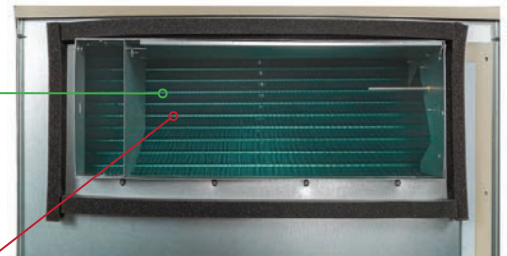
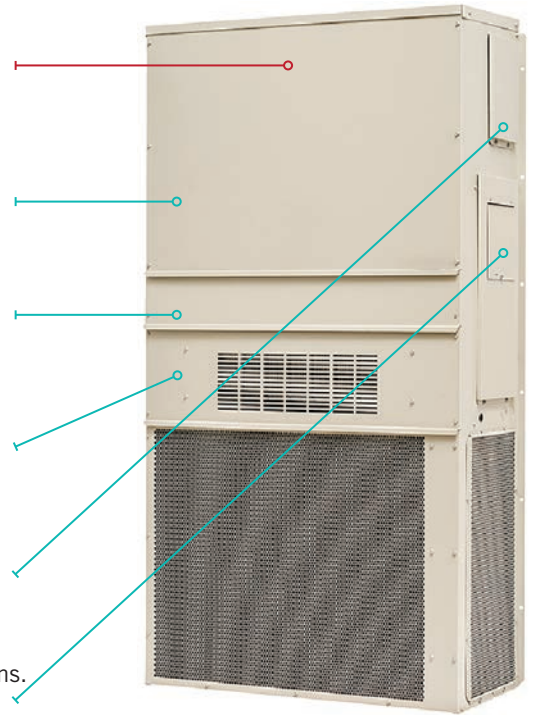

UNIT MODES OF OPERATION

Cooling Operation: The Bard WH Series WALL MOUNT products offer single stage cooling operation using R410A refrigerant. Copper tube/Aluminum fin coils are used to provide high efficiency and easy serviceability. Scroll compressor technology delivers years of quiet, reliable operation.



Heating Operation: The Bard WH Series WALL MOUNT products offer single stage heat pump operation and optional single or two stage heating operation using resistance heaters. Circuit breaker disconnect protection is standard in all units equipped with electric heat.



Ventilation Operation: The Bard WH Series WALL MOUNT products offer optional ventilation that brings outdoor air into the structure. Vent options can be factory or field installed, and can be used to bring in outdoor air for occupants, save energy by using outdoor air for free cooling, or positively pressurize a structure. Exhaust air options allow room air to be vented outdoors when fresh air is being brought into the structure. Energy recovery options are also available for occupied structures which condition the air being brought in to save energy when ventilation is necessary regardless of outdoor temperature.



Balanced Climate™ Operation: The Bard WH Series WALL MOUNT products offer an enhanced latent capacity stage that can be controlled by a two stage cooling thermostat. During the first cooling stage (Balanced Climate Mode), the unit will increase the amount of moisture removed during compressor operation. The second stage (standard mode) of cooling increases the sensible cooling capacity to increase the amount of heat removed from the structure during compressor operation. Available in high supply static applications. In order for Balanced Climate to be used, a jumper must be removed between Y1 and Y2. Unit is shipped with jumper in place and Balanced Climate disabled.



ADVANCED FEATURE DESCRIPTIONS

ECM Indoor Blower Motor: Energy efficient indoor blower motors use EC constant torque technology with 5 pre-programmed speeds. By selecting the needed speed, the WALL MOUNT product can reduce or increase airflow. A NEMA48® frame enclosure is used. A medium and high speed tap can be user selected to offer the maximum CFM possible with the blower assembly.

- Efficient 5 speed ECM constant torque motor. 24VAC power used for speed selection.
- Fully potted electronic control module for moisture protection.
- 6000V surge protection.
- Dual shaft design with open air over (OAO) enclosure.



Outdoor Fan Motor: Outdoor fan motors use ball bearing construction and are fully enclosed for increased life expectancy.

- Single speed PSC motor.
- Totally enclosed motor housing protects motor windings and internal components from corrosion.
- Ball bearing design reduces motor wear from “windmill” affect when not in operation.



Non Fiberglass Cabinet Insulation: The WH MOUNT products use advanced non-fiberglass insulation that is made with recycled denim materials. High "R" value, enhanced sound absorption, and reduced delamination are some of the features of this revolutionary product.

- Easy to clean and damage resistant Foil FSK Facing.
- Fiberglass and Formaldehyde free.
- Meets ASTM E84, UL 723, NFPA 90A and 90B Standards.
- Thermal performance ASTM C518 k=.27@1" & 900gsm



////// CAPACITY AND EFFICIENCY RATINGS

MODELS	J18HB	J24HB	J30HB	J36HB
Total Cooling Capacity BTUH ①	17,500	23,500	29,100	36,000
EER ②	11.0	11.0	11.0	11.0
High Temp Heating (47F) BTUH ①	16,800	22,383	26,083	31,660
COP ②	3.5	3.5	3.4	3.3
Low Temp Heating (17F) BTUH ①	9,685	13,623	16,917	21,100
COP ②	2.17	2.33	2.34	2.30

① Cooling and Heating Capacities are certified in accordance with ANSI/ARI Standard 390-2003.

② EER = Energy Efficiency Ratio. COP = Coefficient of Performance. Energy efficiency data is certified in accordance with ANSI/ARI Standard 390-2003.

////// SPECIFICATIONS 1-1/2 TON THROUGH 3 TON

MODELS	J18HB-A	J24HB-A	J24HB-B	J24HB-C	J30HB-A	J30HB-B	J30HB-C	J36HB-A	J36HB-B	J36HB-C
Electrical Rating – 60 Hz	230/208 - 1	230/208 - 1	230/208 - 3	460 - 3	230/208 - 1	230/208 - 3	460 - 3	230/208 - 1	230/208 - 3	460 - 3
Operating Voltage Range	197-253	197-253	197-253	414-506	197-253	197-253	414-506	197-253	197-253	414-506
Compressor--Circuit A										
Voltage	230/208	230/208	230/208	460	230/208	230/208	460	230/208	230/208	460
Rated Load Amps	6.0/6.9	8.3/9.4	5.0/5.7	2.8	9.6/11.3	6.2/8.2	3.4	12.4/14.1	8.0/9.1	5.1
Branch Circuit Selection Current	9.0	10.9	6.5	3.6	14.2	9.0	4.2	16.7	10.5	5.8
Lock Rotor Amps	48/48	58.3/58.3	55.4/55.4	28	73/73	58/58	28	112/112	73/73	38
Compressor Type	Scroll	Scroll	Scroll	Scroll	Scroll	Scroll	Scroll	Scroll	Scroll	Scroll
Fan Motor & Condenser										
Fan Motor--HP--RPM	1/6 - 1090	1/6 - 1090	1/6 - 1090	1/5 - 1075	1/5 - 1075	1/5 - 1075	1/5 - 1075	1/5 - 1075	1/5 - 1075	1/5 - 1075
Fan Motor--Amps	1.1	1.1	1.1	0.6	1.6	1.6	1.2	1.4	1.4	0.9
Fan--DIA/CFM	18" - 1800	18" - 1800	18" - 1800	18" - 1800	20" - 2400	20" - 2400	20" - 2400	20" - 2200	20" - 2200	20" - 2200
Blower Motor & Evap.										
Blower Motor--HP-SPD	1/3-5	1/3-5	1/3-5	1/3-5	1/2	1/2-5	1/2-5	1/2-5	1/2-5	1/2-5
Blower Motor--Amps	1	0.7	1.3	.8	2.3	1.2	1.0	2.3	2.3	1.2
Motor Type	ECM	ECM	ECM	ECM	ECM	ECM	ECM	ECM	ECM	ECM
CFM Cooling & E.S.P. w/Filter (Rated-Wet Coil)	600 - .1	800 - .1	800 - .1	800 - .1	950 - .15	950 - .15	950 - .15	1150 - .15	1150 - .15	1150 - .15
Filter Sizes (inches) STD.	16x25x1	16x25x1	16x25x1	16x25x1	16x30x1	16x30x1	16x30x1	16x30x1	16x30x1	16x30x1
Basic Unit Weight-LBS.										
Barometric Fresh Air Damper (X)	4.0	4.0	4.0	4.0	5.0	5.0	5.0	5.0	5.0	5.0
Barometric Damper w/ Exhaust (A)	8.0	8.0	8.0	8.0	9.0	9.0	9.0	9.0	9.0	9.0
Blank-Off Plate (B)	1.0	1.0	1.0	1.0	1.0	1.0	1.0	1.0	1.0	1.0
Commercial Room Ventilator (M, V)	31.0	31.0	31.0	31.0	35.0	35.0	35.0	35.0	35.0	35.0
Economizer (D, S, Y, Z)	37.0	37.0	37.0	37.0	37.0	37.0	37.0	37.0	37.0	37.0
Energy Recovery Ventilator (R)	54.0	54.0	54.0	54.0	65.0	65.0	65.0	65.0	65.0	65.0

////// OPTIONAL SHIPPING CRATES

Optional crates are available to help protect your valuable WALL MOUNT investment during shipping. Constructed from OSB sheathing with steel corner posts, and sized for standard truck transportation. Treated for pests in accordance with the International Plant Protection Convention, Publication 15, Annex 1. Packaging is acceptable for international shipments.

CRATE NO.	UNITS USING CRATE	DESCRIPTION
8620-263	J18H, J24H	Standard Unit Crate
8620-275	J18H, J24H	Units with "Y or Z" Economizer With Factory Installed 7" Hood
8620-262	J30H, J36H	Standard Unit Crate
8620-276	J30H, J36H	Units with "Y or Z" Economizer With Factory Installed 7" Hood

COOLING APPLICATION DATA - OUTDOOR TEMPERATURE °F ①②

MODEL	RETURN AIR (DB/WB)	COOLING CAPACITY	75°F	80°F	85°F	90°F	95°F	100°F	105°F	110°F	115°F	120°F	125°F
J18	75/62	Total Cooling	19700	18500	17300	16300	15300	14500	13600	12900	12300	11700	11100
		Sensible Cooling	15200	14600	14000	13500	13000	12600	12200	11800	11600	11400	11100
	80/67	Total Cooling	21000	20100	19200	18400	17500	16800	16000	15300	14700	14100	13500
		Sensible Cooling	14700	14300	13800	13500	13100	12800	12500	12200	12000	11900	11700
	85/72	Total Cooling	25100	23500	22100	20800	19500	18400	17300	16300	15500	14700	13900
		Sensible Cooling	15100	14600	13900	13400	12900	12400	12000	11500	11100	10800	10400
J24	75/62	Total Cooling	25700	24300	23000	21700	20500	19400	18300	17300	16300	15400	14500
		Sensible Cooling	20100	19500	18900	18300	17800	17200	16600	16100	15500	15000	14500
	80/67	Total Cooling	27400	26400	25500	24500	23500	22600	21600	20600	19600	18600	17600
		Sensible Cooling	19500	19100	18700	18300	17900	17500	17000	16600	16100	15700	15200
	85/72	Total Cooling	32700	30900	29300	27700	26100	24800	23300	21900	20600	19400	18100
		Sensible Cooling	20000	19400	18800	18200	17600	17000	16200	15600	14900	14200	13500
J30	75/62	Total Cooling	31900	30100	28500	26900	25400	24100	22700	21500	20300	19200	18200
		Sensible Cooling	25700	24900	24100	23300	22700	22000	21500	20900	20300	19200	18200
	80/67	Total Cooling	34000	32800	31600	30400	29100	28000	26800	25600	24400	23200	22100
		Sensible Cooling	24900	24400	23800	23300	22900	22400	22000	21600	21300	21000	20700
	85/72	Total Cooling	40500	38400	36300	34300	32400	30700	28900	27300	25700	24100	22800
		Sensible Cooling	25500	24800	23900	23200	22500	21700	21000	20300	19600	19000	18300
J36	75/62	Total Cooling	39600	37400	35200	33300	31400	29700	28100	26600	25200	23900	22800
		Sensible Cooling	30600	29500	28400	27400	26600	25800	25000	24300	23700	23100	22600
	80/67	Total Cooling	42300	40700	39100	37600	36000	34600	33100	31700	30300	29000	27700
		Sensible Cooling	29700	28900	28100	27400	26800	26200	25600	25100	24600	24200	23800
	85/72	Total Cooling	50400	47600	44900	42500	40000	37900	35700	33700	31900	30200	28500
		Sensible Cooling	30400	29400	28300	27200	26300	25400	24400	23600	22700	21900	21100

- ① Low ambient control allows for compressor operation down to 0°F.
 ② Outdoor temperatures shown are measured at the condenser section air inlet.
 ③ Return air temperature °F.

CAPACITY MULTIPLIER FACTORS			
% of Rated Airflow	-10	Rated	+10
Total BTUH	0.975	1.0	1.02
Sensible BTUH	0.950	1.0	1.05

HEATING APPLICATION RATING AND OUTDOOR TEMPERATURE °F ①②

MODEL		0°F	5°F	10°F	15°F	20°F	25°F	30°F	35°F	40°F	45°F	47°F	50°F	55°F	60°F	65°F
J18HB	BTUH	6,005	7,062	8,140	9,240	10,362	11,506	12,672	13,859	15,069	16,301	16,800	17,554	18,830	20,127	21,447
	WATTS	1,271	1,279	1,288	1,298	1,309	1,320	1,332	1,346	1,360	1,375	1,381	1,391	1,408	1,425	1,444
	COP	1.38	1.61	1.85	2.08	2.32	2.55	2.78	3.01	3.24	3.47	3.5	3.69	3.91	4.13	4.35
J24HB	BTUH	9,277	10,509	11,779	13,089	14,437	15,823	17,248	18,712	20,215	21,756	22,383	23,336	24,954	26,611	28,306
	WATTS	1,618	1,646	1,672	1,698	1,724	1,749	1,773	1,797	1,820	1,843	1,852	1,865	1,887	1,908	1,928
	COP	1.67	1.87	2.06	2.25	2.45	2.65	2.85	3.05	3.25	3.45	3.5	3.66	3.87	4.08	4.30
J30HB	BTUH	13,230	14,201	15,267	16,426	17,680	19,029	20,471	22,009	23,640	25,366	26,083	27,186	29,101	31,110	33,213
	WATTS	2,053	2,070	2,089	2,109	2,129	2,151	2,175	2,199	2,224	2,251	2,262	2,279	2,308	2,338	2,369
	COP	1.88	2.00	2.14	2.28	2.43	2.59	2.75	2.93	3.11	3.30	3.4	3.49	3.69	3.89	4.10
J36HB	BTUH	17,423	18,331	19,383	20,580	21,922	23,407	25,037	26,812	28,731	30,794	31,660	33,001	35,353	37,849	40,490
	WATTS	2,627	2,635	2,647	2,663	2,682	2,705	2,732	2,763	2,798	2,837	2,853	2,879	2,925	2,975	3,028
	COP	1.94	2.03	2.14	2.26	2.39	2.53	2.68	2.84	3.00	3.18	3.3	3.35	3.54	3.72	3.91

Performance given for 70°F DB indoor return air at rated CFM. Data includes defrost operation below 45° outdoor temperature.

- ① Supplemental Electric heaters are recommended for applications requiring heating below a 15°F outdoor temperature.
 ② Outdoor temperatures shown are measured at the condenser section air inlet.

UNIT CHARGE RATES

UNIT	STD. UNIT - LBS.	DEHUM. UNITS - LBS.
J18HC - 11 EER Heat Pump	4.375	N/A
J24HC - 11 EER Heat Pump	5.250	N/A
J30HC - 11 EER Heat Pump	7.000	6.875
J36HC - 11 EER Heat Pump	8.000	7.500

////// BALANCED CLIMATE APPLICATION DATA (OPTIONAL, REQUIRES 2 STAGE COOLING THERMOSTATS)

MODEL	RETURN AIR (DB/WB)	COOLING CAPACITY	75°F	80°F	85°F	90°F	95°F	100°F	105°F	110°F	115°F	120°F	125°F
J18	75/62	Total Cooling	17900	17400	16800	16100	15500	14800	14100	13400	12600	11800	10900
		Sensible Cooling	12500	12600	12700	12500	12400	12100	11700	11400	10800	10200	9400
		Latent Cooling	5400	4800	4100	3600	3100	2700	2400	2000	1800	1600	1500
	80/67	% Latent Increase	5.08	4.52	3.86	3.39	2.92	2.54	2.26	1.88	1.69	1.51	1.41
		Lbs. H2O per Hr.	0.85	0.85	0.75	0.75	0.75	0.75	0.94	0.85	1.03	1.22	1.41
		Total Cooling	19100	18900	18600	18200	17800	17200	16600	15900	15100	14200	13200
	85/72	Sensible Cooling	12100	12300	12500	12500	12500	12300	12000	11700	11200	10600	9900
		Latent Cooling	7000	6600	6100	5700	5300	4900	4600	4200	3900	3600	3300
		% Latent Increase	6.60	6.23	5.75	5.38	5.00	4.62	4.34	3.96	3.68	3.40	3.10
85/72	Lbs. H2O per Hr.	0.66	0.75	0.66	0.75	0.85	0.85	1.04	1.04	1.13	1.32	1.41	
	Total Cooling	22800	22100	21400	20600	19800	18900	17900	17000	15900	14800	13600	
	Sensible Cooling	12400	12500	12600	12500	12300	11900	11500	11000	10400	9600	8800	
85/72	Latent Cooling	10400	9600	8800	8100	7500	7000	6400	6000	5500	5200	4800	
	% Latent Increase	9.84	9.08	8.32	7.66	7.09	6.62	6.05	5.68	5.20	4.92	4.52	
	Lbs. H2O per Hr.	0.38	0.66	0.57	0.66	0.85	0.95	1.04	1.14	1.04	1.23	1.22	
J24	75/62	Total Cooling	24500	23300	22200	21100	20000	19000	18000	17100	16200	15400	14500
		Sensible Cooling	17500	17000	16500	16000	15500	15100	14600	14100	13600	13100	12700
		Latent Cooling	7000	6300	5700	5100	4500	3900	3400	3000	2600	2300	1800
	80/67	% Latent Increase	6.59	5.93	5.36	4.80	4.23	3.67	3.20	2.82	2.45	2.16	1.69
		Lbs. H2O per Hr.	1.32	1.41	1.51	1.60	1.69	1.60	1.60	1.69	1.69	1.79	1.69
		Total Cooling	26100	25400	24600	23800	22900	22100	21200	20400	19500	18600	17600
	85/72	Sensible Cooling	16900	16600	16300	16000	15600	15300	14900	14500	14100	13700	13300
		Latent Cooling	9200	8800	8300	7800	7300	6800	6300	5900	5400	4900	4300
		% Latent Increase	8.68	8.30	7.83	7.36	6.89	6.42	5.94	5.57	5.09	4.62	4.06
85/72	Lbs. H2O per Hr.	1.23	1.42	1.42	1.51	1.60	1.60	1.60	1.79	1.79	1.89	1.79	
	Total Cooling	31100	29700	28300	26900	25500	24200	22900	21700	20500	19400	18100	
	Sensible Cooling	17300	16900	16400	15900	15300	14800	14200	13600	13000	12400	11800	
85/72	Latent Cooling	13800	12800	11900	11000	10200	9400	8700	8100	7500	7000	6300	
	% Latent Increase	13.05	12.11	11.26	10.40	9.65	8.89	8.23	7.66	7.09	6.62	5.96	
	Lbs. H2O per Hr.	1.04	1.23	1.32	1.42	1.61	1.51	1.51	1.70	1.70	1.70	1.61	
J30	75/62	Total Cooling	29600	28200	26900	25500	24200	23000	21800	20600	19400	18300	17100
		Sensible Cooling	21700	20900	20300	19700	19200	18500	18000	17400	16900	16300	15700
		Latent Cooling	7900	7300	6600	5800	5000	4500	3800	3200	2500	2000	1400
	80/67	% Latent Increase	7.43	6.87	6.21	5.46	4.70	4.23	3.58	3.01	2.35	1.88	1.32
		Lbs. H2O per Hr.	1.60	1.98	2.07	2.07	2.16	2.26	2.45	2.45	2.45	2.35	1.88
		Total Cooling	31600	30700	29800	28800	27800	26800	25700	24500	23300	22100	20800
	80/67	Sensible Cooling	21000	20500	20100	19700	19300	18800	18400	17900	17500	17000	16500
		Latent Cooling	10600	10200	9700	9100	8500	8000	7300	6600	5800	5100	4300
		% Latent Increase	10.00	9.62	9.15	8.58	8.02	7.55	6.89	6.23	5.47	4.81	4.06
85/72	Lbs. H2O per Hr.	1.42	1.70	1.79	1.89	2.17	2.26	2.36	2.45	2.55	2.74	2.74	
	Total Cooling	37700	35900	34300	32500	30900	29300	27700	26100	24500	23000	21400	
	Sensible Cooling	21500	20800	20200	19600	19000	18200	17600	16800	16200	15400	14600	
85/72	Latent Cooling	16200	15100	14100	12900	11900	11100	10100	9300	8300	7600	6800	
	% Latent Increase	15.32	14.28	13.34	12.20	11.26	10.50	9.55	8.80	7.85	7.19	6.43	
	Lbs. H2O per Hr.	1.14	1.42	1.61	1.70	1.89	1.99	2.08	2.18	2.08	2.36	2.18	
J36	75/62	Total Cooling	36600	34900	33300	31700	30200	28600	27100	25800	24300	23000	21500
		Sensible Cooling	25700	24900	24300	23400	22700	22000	21300	20500	19800	19100	18500
		Latent Cooling	10900	10000	9000	8300	7500	6600	5800	5300	4500	3900	3000
	80/67	% Latent Increase	10.26	9.41	8.47	7.81	7.06	6.21	5.46	4.99	4.23	3.67	2.82
		Lbs. H2O per Hr.	1.79	1.98	2.07	2.26	2.54	2.54	2.54	2.82	2.82	2.92	2.63
		Total Cooling	39000	38000	36900	35800	34600	33300	32000	30700	29200	27800	26200
	80/67	Sensible Cooling	24900	24400	24000	23400	22900	22400	21800	21200	20600	20000	19400
		Latent Cooling	14100	13600	12900	12400	11700	10900	10200	9500	8600	7800	6800
		% Latent Increase	13.30	12.83	12.17	11.70	11.04	10.28	9.62	8.96	8.11	7.36	6.42
85/72	Lbs. H2O per Hr.	1.42	1.70	1.79	2.08	2.36	2.36	2.55	2.74	2.74	2.83	2.74	
	Total Cooling	46500	44500	42400	40400	38500	36400	34500	32700	30700	28900	27000	
	Sensible Cooling	25500	24800	24100	23300	22500	21700	20800	19900	19000	18100	17200	
85/72	Latent Cooling	21000	19700	18300	17100	16000	14700	13700	12800	11700	10800	9800	
	% Latent Increase	19.86	18.63	17.31	16.17	15.13	13.90	12.96	12.11	11.07	10.22	9.27	
	Lbs. H2O per Hr.	0.95	1.42	1.61	1.70	2.18	2.08	2.27	2.55	2.36	2.36	2.27	

- ① Low ambient operation disables Balanced Climate Operation.
- ② Outdoor temperatures shown are measured at the condenser section air inlet.
- ③ Return air temperature °F.
- ④ % Latent increase is a comparison to non-Balanced Climate unit operation.
- ⑤ Units with mechanical dehumidification rated to 125°F outdoor temperatures.

CAPACITY MULTIPLIER FACTORS			
	% of Rated Airflow	-10	+10
	Total BTUH	0.975	1.02
	Sensible BTUH	0.950	1.05

INDOOR AIRFLOW CFM @ STATIC PRESSURES - EC BLOWER CONSTANT TORQUE MOTOR WITH ADJUSTMENT SPEEDS

ESP	J18HB BLOWER TAPS - DRY/WET COIL CFM					J24HB BLOWER TAPS - DRY/WET COIL CFM				
In H2O	Blower and Vent Only	Balanced Climate	Default LO Cooling and Heating	Optional MED Cooling and Heating	Optional HI Cooling and Heating	Blower and Vent Only	Balanced Climate	Default LO Cooling and Heating	Optional MED Cooling and Heating	Optional HI Cooling and Heating
0"	665/648	600/583	665/648	756/746	799/794	840/834	653/636	840/834	960/953	1115/1110
.1"	600/584	500/486	600/584	722/709	775/764	818/809	583/567	818/809	934/930	1075/1070
.15"	568/553	453/439	568/553	704/690	760/747	806/794	549/534	806/794	926/915	1058/1044
.2"	537/523	407/394	537/523	684/670	745/730	793/778	516/501	793/778	915/898	1040/1014
.3"	477/464	Not Used	477/464	643/629	708/693	758/742	Not Used	758/742	880/856	988/944
.4"	420/407	Not Used	420/407	598/586	665/652	716/701	Not Used	716/701	831/806	912/860
.5"	365/352	Not Used	365/352	549/542	616/608	664/655	Not Used	664/655	767/747	814/761

ESP	J30HB BLOWER TAPS - DRY/WET COIL CFM					J36HB BLOWER TAPS - DRY/WET COIL CFM				
In H2O	Blower and Vent Only	Balanced Climate	Electric Heat Operation Only*	Default LO Cooling and Heating	Optional HI Cooling and Heating	Blower and Vent Only	Balanced Climate	Default LO Cooling and Heating	Optional MED Cooling and Heating	Optional HI Cooling and Heating
0"	1083/1063	856/823	1175/1156	1083/1063	1372/1355	1175/1156	929/903	1175/1156	1372/1355	1475/1465
.1"	1053/1036	778/751	1157/1138	1053/1036	1361/1335	1157/1138	870/848	1157/1138	1361/1335	1456/1429
.15"	1035/1019	740/713	1143/1124	1035/1019	1348/1318	1143/1124	839/819	1143/1124	1348/1318	1438/1404
.2"	1016/1000	702/674	1128/1107	1016/1000	1331/1297	1128/1107	808/788	1128/1107	1331/1297	1415/1374
.3"	972/953	Not Used	1188/1065	972/953	1284/1242	1188/1065	Not Used	1188/1065	1284/1242	1352/1299
.4"	921/896	Not Used	1039/1010	921/896	1218/1169	1039/1010	Not Used	1039/1010	1218/1169	1267/1203
.5"	863/830	Not Used	978/944	863/830	1135/1080	978/944	Not Used	978/944	1135/1080	1160/1088

Five factory programmed speed taps (torque settings) are available for the indoor blower motor, and are selected through different unit modes of operation. These modes are energized by 24VAC signals from the low voltage terminal block located inside the control panel by a thermostat or other controlling device.

1. Blower and Ventilation Only Speed is the CFM amount for continuous fan and ventilation without a call for cooling.
2. Balanced Climate Speed is the indoor CFM amount for user selectable Balanced Climate operation and optional Mechanical Dehumidification. To use Balanced Climate, remove the jumper between Y1 and Y2 on the low voltage terminal strip. A 2 stage cooling thermostat is then used to control blower airflow stages. Be sure to follow all guidelines provided in the installation manual. A controls kit that includes a low ambient control (LAC) must be used for Balanced Climate Operation if ventilation options are to be used or cooling operation will occur below a 60° outdoor temperature. Balanced Climate can be used for duct free and ducted applications below 0.20"WC ESP total static. Balanced Climate provides increased moisture removal during the cooling cycle, but is not a replacement for optional mechanical dehumidification. Optional mechanical dehumidification provides moisture removal without significantly cooling the space being conditioned. Mechanical dehumidification is highly recommended for applications requiring indoor humidity control for schools, public areas, agricultural, pharmaceutical, and areas with high outdoor humidity and varying indoor heat load.
3. Default LO Cooling and Heating Speed is the indoor CFM amount for cooling operation using the default blower speed tap selection. This speed is labeled as LO on the speed selection terminal strip inside the unit control panel. All units ship with cooling and heating operation at LO cooling and heating speed, and provides the optimal airflow amount for normal use.
4. Optional MED Cooling and Heating Speed is selected manually during unit setup and provides a higher indoor CFM for hi static duct applications and increased airflow. This speed is labeled as MED on the speed selection terminal strip inside the unit control panel. Not available for use with J30H models. The J30H uses a dedicated blower speed for electric heat operation.*
5. Optional HI Cooling and Heating Speed is selected manually during unit setup and provides the highest allowable indoor CFM amount. Not recommended for standard unit operation. This speed is labeled as HI on the speed selection terminal strip inside the unit control panel.

///// ELECTRICAL SPECIFICATIONS - W**HB SERIES

MODEL	Rated Volts & Phase	No. Field Power Circuits	Single Circuit				Dual Circuit									
			① Minimum Circuit Ampacity	② Maximum External Fuse or Ckt. Brkr.	③ Field Power Wire Size	④ Ground Wire	① Minimum Circuit Ampacity		② Maximum External Fuse or Ckt. Breaker		③ Field Power Wire Size		④ Ground Wire Size			
							Ckt. A	Ckt. B	Ckt. A	Ckt. B	Ckt. A	Ckt. B	Ckt. A	Ckt. B		
J18HB-A00, A0Z A04 A08	230/208-1	1 1 1	15 36 57	20 40 60	12 8 6	12 10 10										
J24HB-A00, A0Z A04 A08	230/208-1	1 1 1 or 2	19 39 60	25 45 60	10 8 6	10 10 8	42	25	45	25	8	10	10	10		
J24HB-B00, B0Z B06	230/208-3	1 1	13 31	15 35	12 8	12 10										
J24HB-C00, C0Z C06	460-3	1 1	8 17	10 20	14 12	14 12										
J30HB-A00, A0Z A05 A10	230/208-1	1 1 1 or 2	24 50 76	35 60 80	8 8 4	10 10 8	50	26	50	30	8	10	10	10		
J30HB-B00, B0Z B06 B09	230/208-3	1 1 1	18 36 45	25 40 45	10 8 8	10 10 10										
J30HB-C00, C0Z C06 C09 ③ C15	460-3	1 1 1 1	9 18 23 26	15 20 25 30	14 12 10 10	14 12 10 10										
J36HB-A00, A0Z A05 A10 ④ A15	230/208-1	1 1 1 or 2 1 or 2	27 53 79 84	40 60 90 90	8 6 4 4	10 10 8 8	53	26	60	30	6 6	10 6	10 10	10 10		
J36HB-B00, B0Z B06 B09 ③ B15	230/208-3	1 1 1 1	19 37 47 51	25 40 50 60	10 8 8 6	10 10 10 10										
J36HB-C00, C0Z C06 C09 ③ C15	460-3	1 1 1 1	11 20 25 26	15 20 25 30	14 12 10 10	14 12 10 10										

- (1) The "Minimum Circuit Ampacity" values are to be used for sizing the field power conductors. Refer to the National Electrical Code (latest version), Article 310 for power conductor sizing.
 CAUTION: When more than one field power circuit is run through one conduit, the conductors must be derated. Pay special attention to note 8 of Table 310 regarding Ampacity Adjustment Factors when more than three (3) conductors are in a raceway.
 (2) Maximum size of the time delay fuse or circuit breaker for protection of field wiring conductors.
 (3) Maximum KW that can operate with the heat pump on is 9KW. Full heat available during emergency heat mode.
 (4) Maximum KW that can operate with the heat pump on is 10KW. Full heat available during emergency heat mode.
 (5) Based on 75°C copper wire. All wiring must conform to the National Electrical Code and all local codes.

IMPORTANT: While this electrical data is presented as a guide, it is important to electrically connect properly sized fuses & conductor wires in accordance with the National Electrical Code & all local codes.

///// SOUND DATA - DBA @ 5 FT. AND 10 FT.*

DUCT FREE	INDOOR COOLING OPERATION @ 5 FT.			INDOOR COOLING OPERATION @ 10 FT.			OUTDOOR @ 10 FT.
	Unit	Standard Grilles	With WMICF	With WMICF and WAPR-11	Standard Grilles	With WMICF	
J18HB	49.6	47.3	45.1	47.3	45.2	42.9	66.2
J24HB	52.4	49.7	46.9	50.4	46.9	44.8	67.1
J30HB	53.9	52.8	50.3	52.9	50.4	48.8	67.1
J36HB	53.9	52.8	50.3	52.9	50.4	48.8	67.1

DUCTED SUPPLY	INDOOR COOLING OPERATION @ 5 FT.			INDOOR COOLING OPERATION @ 10 FT.			OUTDOOR @ 10 FT.
	Unit	Standard Grilles	With WMICF	With WMICF and WAPR-11	Standard Grilles	With WMICF	
J18HB	48.6	45.5	46.6	46.2	44.0	43.1	66.2
J24HB	51.9	45.4	47.5	48.9	42.9	44.8	67.1
J30HB	54.5	47.3	51.1	47.3	44.7	48.5	67.1
J36HB	54.5	47.3	51.1	47.3	44.7	48.5	67.1

Integrated values calculated per ANSI/ASA S12.60-2009/Part 2, Section 5.2.2.1, Integrated Sound Vales are also applicable for use in learning spaces for LEED schools; EQ Prerequisite 3 - Minimum Acoustical Performance, OPTION 1. Using methods prescribed in ANSI S12.60, classroom must achieve a maximum background noise level of 45 dBA. Results Referenced Were Recorded In The Bard Manufacturing Company, Inc. Sound Lab Facility. Actual Field Application Results May Vary With Classroom Design and Construction Methods.

////// HEATER PACKAGES - FIELD INSTALLED "A" SERIES RIGHT-HAND UNITS

• Designed for adding Electric Heat to 0 KW Units			• ETL US & Canada Listed			
• Circuit Breaker Standard on 230/208V Models			• Toggle Disconnect Standard on 460V Models			
Air Conditioner Models	-A00 Models 230/208-1		-B00 Models 230/208-3		-C00 Models 460-3	
	Heater Model #	KW	Heater Model #	KW	Heater Model #	KW
J18HB	WMCB-02A EHW18H-A04 EHW18H-A08	0Z 4 8	N/A		N/A	
J24HB	WMCB-03A TBD TBD	0Z 4 8	WMCB-02B TBD TBD	0Z 6	WMPD-01C TBD	0Z 6
J30HB	WMCB-05A TBD TBD	0Z 5 10	WMCB-02B TBD TBD	0Z 6 9	WMPD-01C TBD TBD TBD	0Z 6 9 15
J36HB	WMCB-06A TBD TBD TBD	0Z 5 10 15	WMCB-04B TBD TBD TBD	0Z 6 9 15	WMPD-01C TBD TBD TBD	0Z 6 9 15

////// **ELECTRIC HEAT TABLE - REFER TO ELECTRICAL SPECIFICATIONS FOR AVAILABILITY BY UNIT MODEL**

NOMINAL KW	AT 240V (1)				AT 208V (1)				AT 480V (2)			AT 460V (2)		
	KW	1-PH AMPS	3-PH AMPS	BTUH	KW	1-PH AMPS	3-PH AMPS	BTUH	KW	3-PH AMPS	BTUH	KW	3-PH AMPS	BTUH
4.0	4.0	16.7		13,652	3.00	14.4		10,239						
5.0	5.0	20.8		17,065	3.75	18.0		12,799						
6.0	6.0		14.4	20,478	4.50		12.5	15,359	6.0	7.2	20,478	5.52	6.9	18,840
8.0	8.0	33.3		27,304	6.00	28.8		20,478						
9.0	9.0		21.7	30,717	6.75		18.7	23,038	9.0	10.8	30,717	8.28	10.4	28,260
10.0	10.0	41.7		34,130	7.50	36.1		25,598						
15.0	15.0	62.5	36.1	51,195	11.25	54.1	31.2	38,396	15.0	18.0	51,195	13.80	17.3	47,099

(1) These electric heaters are available in 230/208V units only.

(2) These electric heaters are available in 480V units only.

////// **WALL MOUNT™ VENTILATION OPTION SELECTION CHART**

VENT CODE	FIELD INSTALL KIT	UNIT	OPERATION	DESCRIPTION
X	FAD-NE2	J18HB, J24HB	Barometric	Air damper provides slight positive room pressure during blower operation, No room air exhaust.
	FAD-NE3	J30HB, J36HB	Barometric	
Y	ECON-DB2-*	J18HB, J24HB	JADE Controller	Full flow Economizer that uses the JADE controller and included sensors to operate free cooling. Dry Bulb operation user adjustable. 7" intake hood required.
	ECON-DB3-*	J30HB, J36HB	JADE Controller	
Z	ECON-WD2-*	J18HB, J24HB	JADE Controller	Full flow Economizer that uses the JADE controller and included sensors to operate free cooling. Enthalpy operation user adjustable. 7" intake hood required.
	ECON-WD3-*	J30HB, J36HB	JADE Controller	

* = Insert color to match unit (X= Beige, 1= White, 4= Buckeye Gray, 5= Desert Brown, 8= Dark Bronze)

“X” Vent Code Option – Standard Fresh Air Damper No Exhaust (FAD-NE)

The barometric fresh air damper without exhaust is a standard feature on all models. It is installed on the inside of the service door and allows outside ventilation air, up to 25% of the total airflow rating of the unit, to be introduced through the air inlet openings and to be mixed with the conditioned air. The damper opens during blower operation and closes when the blower is off. Adjustable blade stops allow different amounts of outside air to be introduced into the building and can be easily locked closed if required. The room exhaust air path is sealed with an insulated block-off plate.

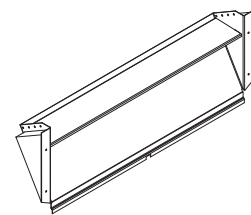

Barometric Fresh Air Damper MS-3754

“Y and Z” Vent Code Option – Economizers with JADE® Controller (ECON-DB, ECON-WD)

The JADE controlled economizer is internally mounted behind the service door and allows outside ventilation air. The ECON-WD allows up to 100% of the total airflow rating of the unit. Both include a built-in exhaust air damper for room pressurization relief. The economizer is designed to provide “free cooling” when outside air conditions are cool and dry enough to satisfy cooling requirements without running the compressor. This provides lower operating costs, extended equipment life, and cooling operation down to -40°F outdoor temperatures. The “Y and Z” economizer requires a 7” air intake hood.

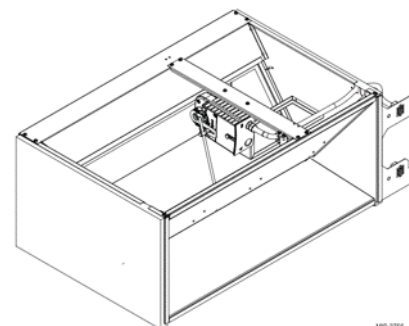

Economizer, Jade Control MS-3756

“Y and Z” Vent Code Option – (ECON-DB, ECON-WD) JADE® Controller Information

JADE Economizer controls provide Demand Ventilation Control, operational checkout, an easy to read LCD screen, configurable freeze protection, and LCD displayed economizer component failure alarms. Minimum vent position, occupancy ventilation, and 0-10V CO2 input is available for use with select CO2 room sensors. Economizer operation can be controlled by outdoor dry bulb (ECON-DB) or outdoor enthalpy (ECON-WB) measurement. When used with a Bard economizer assembly, the JADE controller is able to meet many state and local codes for economizer use.



Jade Control Module

JADE Controller Specifications:

- Operating Humidity Range (% RH) 5 to 95% RH, non-condensing
- Contact Ratings 30 VAC-- 1.5 A Run, 3.5 A Inrush
- Voltage 20 to 30 VAC RMS
- Operating Temperature Range (F) -40 F to +150 F
- Operating Temperature Range (C) -40 C to +65 C
- Approvals, Federal Communications Commission Compliant
- Approvals, CE Compliant
- Complies with California Title 24
- Mixed air and Outdoor Sensor using Sylk Bus.
- Output 2-10 VDC to actuator, Sylk Bus.

WALL MOUNT™ BAROMETRIC DAMPER (FAD) PERFORMANCE

“X” (FAD-NE2 and FAD-NE3) Barometric Damper Without Exhaust Vent Code Options

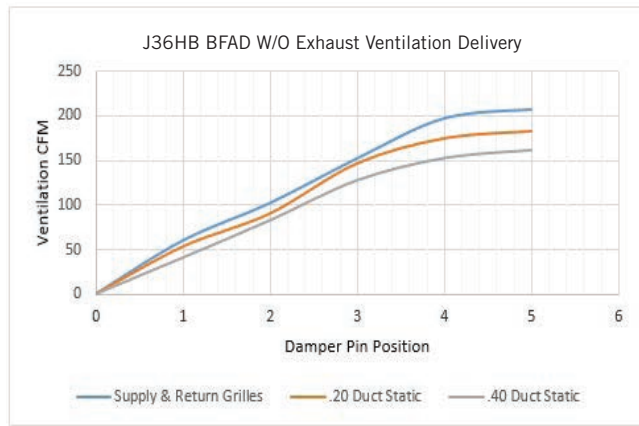
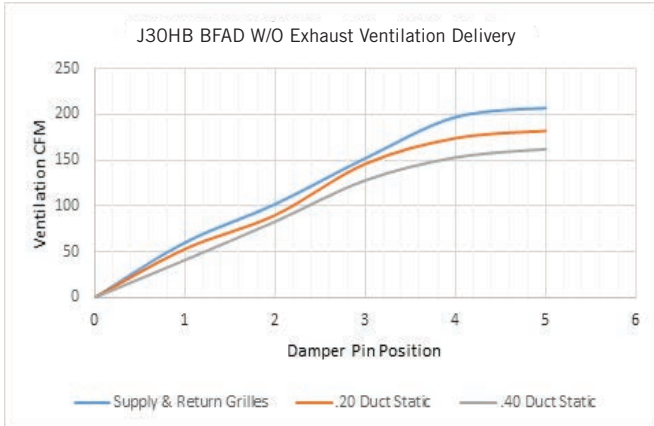
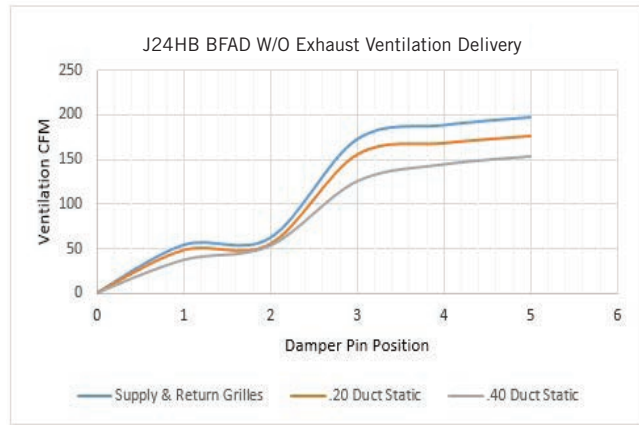
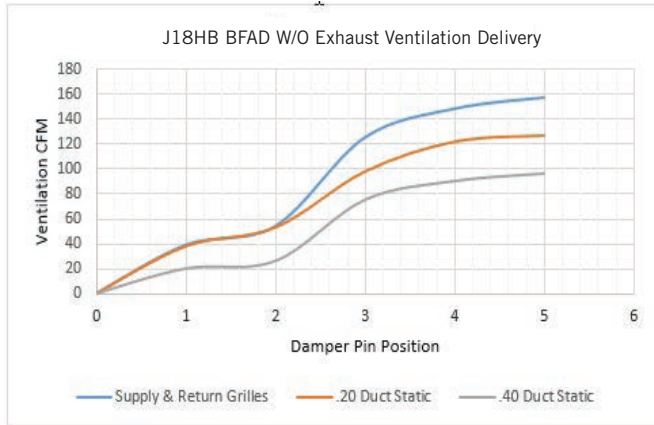

“Y” (ECON-DB) and “Z” (ECON-WD) Vent Code Options

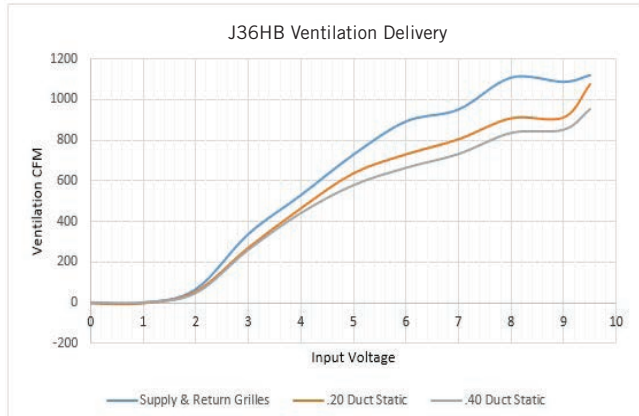
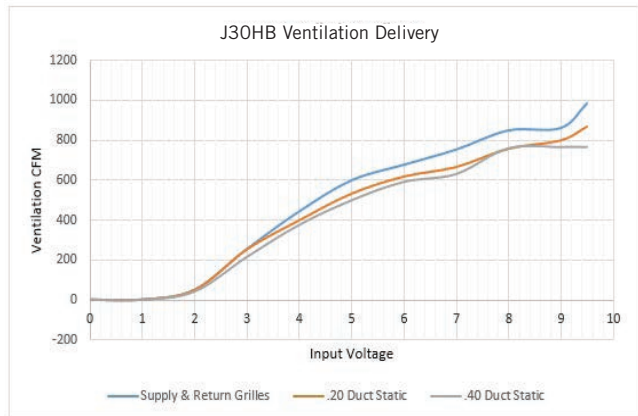
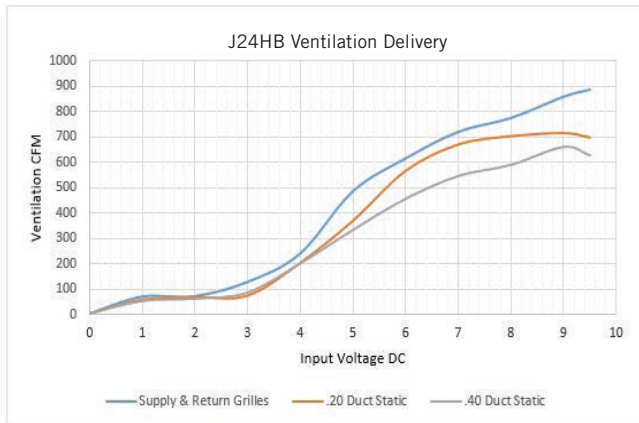
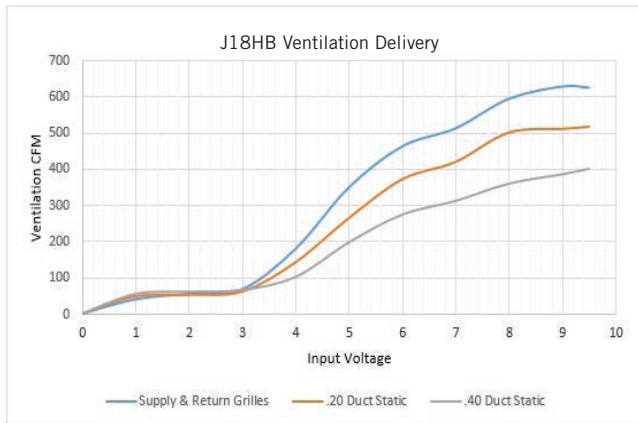

WALL MOUNT™ ENERGY RECOVERY VENTILATION (ERV) PERFORMANCE

"R" (ERV-FA2 and ERV-FC2) Vent Code Options for J18 & J24
 SUMMER COOLING PERFORMANCE (INDOOR DESIGN CONDITIONS 75°DB/62°WB)

AMBIENT O.D.	VENTILATION RATE -- 250 CFM 62% EFFICIENCY							VENTILATION RATE -- 225 CFM 63% EFFICIENCY						VENTILATION RATE -- 200 CFM 63% EFFICIENCY					
	DB/WB	F	VLT	VLS	VLL	HRT	HRS	HRL	VLT	VLS	VLL	HRT	HRS	HRS	VLT	VLS	VLL	HRT	HRS
105	75	11925	8100	1325	7394	5022	822	10727	7287	3441	6758	4591	2168	9540	6480	3060	6010	4082	1928
	70	8100	8100	0	5022	5022	0	7287	7287	0	4591	4591	0	6480	6480	0	4082	4082	0
	65	8100	8100	0	5022	5022	0	7287	7287	0	4591	4591	0	6480	6480	0	4082	4082	0
100	80	17550	6750	10800	10881	4185	6696	15788	6072	9716	9946	3826	6121	14040	5400	8640	8845	3402	5443
	75	11925	6750	5175	7394	4185	3209	10727	6072	4655	6758	3826	2933	9540	5400	4140	6010	3402	2608
	70	6863	6750	113	4255	4185	70	6173	6072	101	3889	3826	64	5490	5400	90	3458	3402	56
	65	6750	6750	0	4185	4185	0	6072	6072	0	3826	3826	0	5400	5400	0	3402	3402	0
95	80	17550	5400	12150	10881	3348	7533	15788	4858	10930	9946	3060	6886	14040	4320	9720	8845	2722	6124
	75	11925	5400	6525	7394	3348	4046	10727	4858	5870	6758	3060	3698	9540	4320	5220	6010	2722	3289
	70	6863	5400	1463	4255	3348	907	6173	4858	1315	3889	3060	829	5490	4320	1170	3458	2722	737
	65	5400	5400	0	3348	3348	0	4858	4858	0	3060	3060	0	4320	4320	0	2722	2722	0
90	80	17550	4050	13500	10881	2511	8370	15788	3643	12145	9946	2295	7651	14040	3240	10800	8845	2041	6804
	75	11925	4050	7875	7394	2511	4883	10727	3643	7084	6758	2295	4463	9540	3240	6300	6010	2041	3969
	70	6863	4050	2813	4255	2511	1744	6173	3643	2530	3889	2295	1594	5490	3240	2250	3458	2041	1417
	65	4050	4050	0	2511	2511	0	3643	3643	0	2295	2295	0	3240	3240	0	2041	2041	0
85	80	17550	2700	14850	10881	1674	9207	15788	2429	13359	9946	1530	8416	14040	2160	11880	8845	1361	7484
	75	11925	2700	9225	7394	1674	5720	10727	2429	8298	6758	1530	5228	9540	2160	7380	6010	1361	4649
	70	6863	2700	4163	4255	1674	2581	6173	2429	3744	3889	1530	2359	5490	2160	3300	3458	1361	2098
	65	2700	2700	0	1674	1674	0	2429	2429	0	1530	1530	0	2160	2160	0	1361	1361	0
80	75	11925	1350	10575	7394	837	6557	10727	1214	9513	6758	765	5993	9540	1080	8460	6010	680	5330
	70	6863	1350	5513	4255	837	3418	6173	1214	4959	3889	765	3124	5490	1080	4410	3458	680	2778
	65	2363	1350	1013	1465	837	628	2125	1214	911	1339	765	547	1890	1080	810	1190	680	510
	60	1350	1350	0	837	837	0	1214	1214	0	765	765	0	1080	1080	0	680	680	0
75	70	6863	0	6863	4255	0	4255	6173	0	6173	6889	0	3889	5490	0	5490	3458	0	3458
	65	2363	0	2363	1465	0	1465	2125	0	2125	1339	0	1339	1890	0	1890	1190	0	1190
	60	0	0	0	0	0	0	0	0	0	0	0	0	0	0	0	0	0	0

WERVP-A2 WINTER HEATING PERFORMANCE (INDOOR DESIGN CONDITIONS 70°F DB)

AMBIENT O.D.	VENTILATION RATE					
	250 CFM 74% EFF.		225 CFM 75% EFF.		200 CFM 75% EFF.	
DB/°F	WVL	WVL	WVL	WVL	WVL	WHR
65	1350	999	1214	911	1080	810
60	2700	1998	2429	1822	2160	1620
55	4050	2997	3643	2733	3240	2430
50	5400	3996	4858	3643	4320	3240
45	6750	4995	6072	4554	5400	4050
40	8100	5994	7287	5465	6480	4860
35	9450	6993	8501	6376	7560	5670
30	10800	7992	9716	7287	8640	6480
25	12150	8991	10930	8198	9720	7290
20	13500	9990	12145	9108	10800	8100
15	14850	10989	13359	10019	11880	8910

NOTE: Sensible performance only is shown for winter application.

LEGEND:

- VLT = Ventilation Load - Total
- VLS = Ventilation Load - Sensible
- VLL = Ventilation Load - Latent
- HRT = Heat Recovery - Total
- HRS = Heat Recovery - Sensible
- HRL = Heat Recovery - Latent
- WVL = Winter Ventilation Load
- WHR = Winter Heat Recovery

WALL MOUNT™ ENERGY RECOVERY VENTILATION (ERV) PERFORMANCE

“R” (ERV-FA3 and ERV-FC3) Vent Code Options for J30 & J36
 SUMMER COOLING PERFORMANCE (INDOOR DESIGN CONDITIONS 75°DB/62°WB)

AMBIENT O.D.	VENTILATION RATE -- 400CFM 63% EFFICIENCY							VENTILATION RATE -- 325 CFM 64% EFFICIENCY						VENTILATION RATE -- 250 CFM 65% EFFICIENCY					
	DB/WB	F	VLT	VLS	VLL	HRT	HRS	HRL	HRS	HRS	HRS	HRS	HRS	HRL	HRS	HRS	HRS	HRS	HRS
105	75	19080	12960	6120	12020	8164	3855	15502	10530	4972	9921	6739	3182	11925	8100	3825	7751	5265	2486
	70	12960	12960	0	8164	8164	0	10530	10530	0	6739	6739	0	8100	8100	0	5265	5265	0
	65	12960	12960	0	8164	8164	0	10530	10530	0	6739	6739	0	8100	8100	0	5265	5265	0
100	80	28080	10800	17280	17690	6804	10886	22815	8775	14040	14601	5616	8985	17550	6750	10800	11407	4387	7019
	75	19080	10800	8280	12020	6804	5216	15502	8775	6727	9921	5616	4305	11925	6750	5175	7751	4387	3363
	70	10980	10800	180	6717	6804	113	8921	8775	146	5709	5616	93	6862	6750	112	4460	4387	73
	65	10800	10800	0	6804	6804	0	8775	8775	0	5616	5616	0	6750	6750	0	4387	4387	0
	60	10800	10800	0	6804	6804	0	8775	8775	0	5616	5616	0	6750	6750	0	4387	4387	0
95	80	28080	8640	19440	17690	5443	12247	22815	7020	15795	14601	4492	10108	17550	5400	12150	11407	3510	7897
	75	19080	8640	10440	12020	5443	6577	15502	7020	8482	9921	4492	5428	11925	5400	6525	7751	3510	4241
	70	10980	8640	2340	6917	5443	1474	8921	7020	1901	5709	4492	1216	6862	5400	1462	4460	3510	950
	65	8640	8640	0	5443	5443	0	7020	7020	0	4492	4492	0	5400	5400	0	3510	3510	0
	60	8640	8640	0	5443	5443	0	7020	7020	0	4492	4492	0	5400	5400	0	3510	3510	0
90	80	28080	6480	21600	17690	4082	13608	22815	5265	17550	14601	3369	11232	17550	4050	13500	11407	2632	8774
	75	19080	6480	12600	12020	4082	7938	15502	5265	10237	9921	3369	6552	11925	4050	7875	7751	2632	5118
	70	10980	6480	4500	6917	4082	2835	8921	5265	3656	5709	3369	2340	6862	4050	2812	4460	2632	1828
	65	6480	6480	0	4082	4082	0	5265	5265	0	3369	3369	0	4050	4050	0	2632	2632	0
	60	6480	6480	0	4082	4082	0	5265	5265	0	3369	3369	0	4050	4050	0	2632	2632	0
85	80	28080	4320	23760	17690	2721	14968	22815	3510	19305	14601	2246	12355	17550	2700	14850	11407	1755	9652
	75	19080	4320	14760	12020	2721	9298	15502	3510	11992	9921	2246	7675	11925	2700	9225	7751	1755	5996
	70	10980	4320	6660	6917	2721	4195	8921	3510	5411	5709	2246	3463	6862	2700	4162	4460	1755	2705
	65	4320	4320	0	2721	2721	0	3510	3510	0	2246	2246	0	2700	2700	0	1755	1755	0
	60	4320	4320	0	2721	2721	0	3510	3510	0	2246	2246	0	2700	2700	0	1755	1755	0
80	75	19080	2160	16920	12020	1360	10659	15502	1755	13747	9921	1123	8798	11925	1350	10575	7751	877	6873
	70	10980	2160	8820	6917	1360	5556	8921	1755	7166	5709	1123	4586	6862	1350	5512	4460	877	3583
	65	3780	2160	1620	2381	1360	1020	3071	1755	1316	1965	1123	842	2362	1350	1012	1535	877	658
	60	2160	2160	0	1360	1360	0	1755	1755	0	1123	1123	0	1350	1350	0	877	877	0
75	70	10980	0	10980	6917	0	6917	8921	0	8921	5709	0	5709	6862	0	6862	4460	0	4460
	65	3780	0	3780	2381	0	2380	3071	0	3071	1965	0	1965	2362	0	2362	1535	0	1535
	60	0	0	0	0	0	0	0	0	0	0	0	0	0	0	0	0	0	0

WERVP-*3 WINTER HEATING PERFORMANCE (INDOOR DESIGN CONDITIONS 70°F DB)

AMBIENT O.D.	VENTILATION RATE					
	400 CFM 75% EFFICIENCY		325 CFM 76% EFFICIENCY		250 CFM 77% EFFICIENCY	
DB/°F	WVL	WHR	WVL	WVL	WVL	WVL
65	2160	1620	1755	1333	1350	1039
60	4320	3240	3510	2667	2700	2079
55	6480	4860	5265	4001	4050	3118
50	8640	6480	7020	5335	5400	4158
45	10800	8100	8775	6669	6750	5197
40	12960	9720	10530	8002	8100	6237
35	15120	11340	12285	9336	9450	7276
30	17280	12960	14040	10670	10800	8316
25	19440	14580	15795	12004	12150	9355
20	21600	16200	17550	13338	13500	10395
15	23760	17820	19305	14671	14850	11434

NOTE: Sensible performance only is shown for winter application.

LEGEND:

- VLT = Ventilation Load - Total
- VLS = Ventilation Load - Sensible
- VLL = Ventilation Load - Latent
- HRT = Heat Recovery - Total
- HRS = Heat Recovery - Sensible
- HRL = Heat Recovery - Latent
- WVL = Winter Ventilation Load
- WHR = Winter Heat Recovery

////// CABINET AND COIL OPTIONS

Cabinet Finish Options

Unit models are available in Beige. Painted cabinet construction is comprised of 20 gauge Zinc coated steel. Parts are cleaned, rinsed, sealed, and dried before a polyurethane primer is applied. The cabinet coating is completed with a baked on textured enamel. The resulting finish is designed to withstand 1000 hours of salt spray tests per ASTM B117-03.



X—Beige

Green Fin Hydrophilic Evaporator Coils Standard On All Units

Bard WALL MOUNT products include a green protective coating applied to the aluminum fin stock used for the evaporator coil. The evaporator coil coating is hydrophilic (attracts water) and allows for proper condensate drainage along with mild corrosion protection. Resistance to corrosive agents include ammonia, sodium hydroxide, sodium chloride, acidic solutions and solvents.

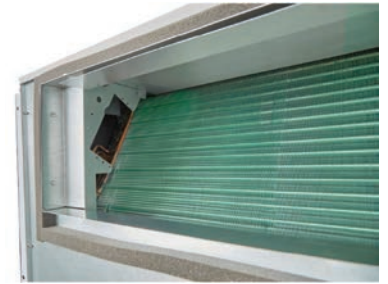

Hydrophilic Green Coil
(standard)

////// WALL MOUNT™ FACTORY INSTALLED CONTROLS OPTIONS

Factory installed controls are provided by Bard to enhance a WALL MOUNT product before it is shipped. All WALL MOUNT products are shipped with a auto-reset high pressure switch and an auto-reset low pressure switch to help protect refrigeration components. A compressor control module with adjustable voltage protection, delay on make and break, and high/low pressure diagnostics is also standard

CONTROL CODE	DESCRIPTION OF FACTORY INSTALLED COMPONENTS
X	Hi Pressure Switch, Low Pressure Switch, Compressor Control Module.
E	Hi Pressure Switch, Low Pressure Switch, Compressor Control Module, Low Ambient Control
NA	Hi Pressure Switch, Low Pressure Switch, Compressor Control Module, Low Ambient Control, Dirty Filter Press. Switch
Q	Hi Pressure Switch, Low Pressure Switch, Compressor Control Module, Outdoor Thermostat
R	Hi Pressure Switch, Low Pressure Switch, Compressor Control Module, Low Ambient Control, Outdoor Thermostat
S	Hi Pressure Control, Low Pressure Switch, Compressor Control Module, PTCR Start Kit
T	Hi Pressure Control, Low Pressure Switch, Compressor Control Module, Low Ambient Control, Outdoor Thermostat, PTCR Start Kit

////// WALL MOUNT™ FIELD INSTALLED KITS

Field installed kits provide accessories that can be installed in the field. Required components, wires, enclosures, screws, and instructions that are needed are provided within the kit.

CONTROL CODE	KIT PART NO.	UNITS USING KIT	DESCRIPTION OF FIELD INSTALLED KIT
E	TBD	J18HB, J24HB, J30HB, J36HB	Low Ambient Control allows compressor cooling between 0°F and 50°F outdoor temp. - fan cycling
E	TBD	J18HB, J24HB, J30HB, J36HB	Low Ambient Control allows compressor cooling between 0°F and 50°F outdoor temp. - modulating
E	TBD	J18HB, J24HB, J30HB, J36HB	Low Ambient Control allows compressor cooling between 0°F and 50°F outdoor temp. - modulating
NA	TBD	J18HB, J24HB, J30HB, J36HB	PTCR Start Kit. Increases starting torque by 2 to 3x. 230V-60hz-1 phase (A voltage) only. Cannot be used in combination with SK start kit
NA	TBD	J18HB, J24HB, J30HB, J36HB	Start Capacitor and Potential Relay Start Kit. Increases starting torque by 9x. 230V-60hz-1 phase (A voltage) only. Cannot be used in combination with CMC start kit
NA	TBD	J18HB, J24HB, J30HB, J36HB	Outdoor Thermostat Kit used to disable compressor cooling below 50°F outdoor temp. Adjustable between 50° and 0°F
NA	TBD	J18HB, J24HB, J30HB, J36HB	Dirty Filter Kit

////// 24VAC LOW VOLTAGE TERMINAL DESIGNATIONS

Bard WALL MOUNT products provide 24VAC power to controllers and thermostats. They also are able to receive 24VAC signals from a controlling device. The V controls option provides additional sensors for use with a field supplied DDC controls systems. The information below provides terminal designations and how they are used in the WALL MOUNT unit. More information on low voltage connections and operational sequences is provided in the unit installation manual.

Terminal	Unit	Description
R	All Units	24VAC low voltage output (HOT Terminal)
RT	All Units	RT terminal has jumper to R terminal. When jumper is removed, R and RT can be used with normally closed contacts for fire/smoke detector for unit shutdown.
C	All Units	Ground Terminal
G	All Units	Indoor fan input
Y1	All Units	1st Stage cooling input. Economizer stage when used. Balanced Climate stage when used.
Y2	All Units	2nd Stage cooling input. Compressor cooling stage when Econ or Balanced Climate is used.
B/W1	All Units	Reversing Valve (energize for heating)
B/W2	All Units	1st Stage electric heat
W3	All Units	2nd State electric heat. Jumper between W2 and W3 must be removed for staged heat
A	Vent option units only	Ventilation option input. Calls for occupied vent air intake for CRV, ERV, ECON
L	All Units	24VAC Alarm active output
1	J Control Opt.	Alarm relay Normally Closed Contact
2	J Control Opt.	Alarm relay Normally Open Contact
3	J Control Opt.	Alarm Relay Common Contact
11	F Control Option	Filter Switch, Normally Open Contacts
12	F Control Option	Filter Switch, Normally Open Contacts

//////// OPTIONAL CONTROLS AND KIT COMPONENT DEFINITIONS

Hi Pressure Control (HPC) - The high pressure control provides a means of protecting the refrigeration circuit when high system pressures occur. It is a auto-reset device that is connected to the Compressor Control Module. When activated, the compressor is disabled until pressures reach an acceptable level. If activated twice in the same cooling call, compressor operation is locked out until the cooling call is interrupted.

Low Pressure Control (LPC) - The low pressure control provides a means of protecting the refrigeration circuit when extremely low system pressures occur. It is a auto-reset device that is connected to the Compressor Control Module. When activated, the compressor is disabled until pressures reach an acceptable level.

Compressor Control Module (CCM) - The compressor control module locks out compressor operation to protect the refrigeration system based on signals from the hi and low pressure switches. It provides diagnostics to indicate when a refrigerant pressure event occurs, and also sends a signal to the alarm relay. Low incoming unit power protection suspends compressor operation when incoming voltage is too low. Suspending compressor operation avoids reverse scroll operation. The low voltage feature is adjustable or can be disabled. An adjustable delay on break timer is provided. Delay on make is 2 mins. plus 10% of delay on break setting.

Alarm Relay (ALR) - The alarm relay provides a set of NO and NC pilot duty contacts that operate when the compressor control module locks out compressor operation because of a high or low system refrigerant pressure event.

Low Ambient Control (LAC) - The low ambient control pressure sensor is attached to the suction line of the system, and monitors low side system pressure. Operation of the LAC occurs as outdoor temperatures drop below the 65°F leads to believe LAC only works to 50°F. On/Off and modulating controls are used. On/Off LAC operation cycles the condenser fan operation based on outdoor temperature. Modulating LAC operation is factory adjusted and slows the condenser fan speed RPM based on outdoor temperature.

Crankcase Heater (CCH) - The heater is a belly band that is installed around the base of the compressor that applies heat when the refrigeration system is not operational. This heat is meant to prevent refrigerant oil migration when the unit is not running. Normal scroll compressor use does not require the use of the CCH, and this option is only recommended for northern areas of the US and Canada with extreme cold operation. Field Install Option Only.

Outdoor Thermostat (ODT) - The outdoor thermostat measures outdoor temperatures and includes relay contacts (NO). The relay is located on the outer control panel and the sensor bulb is mounted to the fan shroud in the outdoor condenser section. When wired into the cooling signal inside the control panel, compressor operation can be disabled when temperatures are below the adjustable setting. Adjustment range is 0°F to 50°F.

PTCR Start Kit - PTCR (Precision Temperature Coefficient Resistor) start kit includes the start device and wires needed for installation. The device is located inside the unit control panel near the compressor capacitor and provides an increase in starting torque. The PTCR Start Kit is not normally required when a clean, stable power source is available for the unit. The kit can only be used in 230 Volt single phase units.

Start Capacitor and Potential Relay Start Kit - The kit includes a start capacitor and relay that is energized during startup of the compressor. The capacitor, relay, and needed wires are provided in a metal enclosure that is field installed in the outdoor section attached to the back. The Start Capacitor Kit is not normally required when a clean, stable power source is available for the unit. The kit can only be used in 230 Volt single phase units. Start capacitor kit cannot be used with the PTCR start kit installed.

Dirty Filter Switch Indicator (DFS) - The switch is adjustable and measures pressure drop across the unit filter surface. When pressure drop is higher than the switch setting NO and NC contacts are provided to indicate the filter needs to be serviced.

Discharge Air Sensor - The discharge air sensor provides a temperature reading of the supply air leaving the unit. The sensor is a 10K OHM @ 77°F measuring device. It is installed in the supply airstream in the heater bracket.

Airflow Switch - The airflow switch measures the pressure differential between the blower inlet and outlet. It is located directly above the blower partition. Relay contacts (NO) are provided for V controls option that indicates the indoor blower assembly needs to be serviced. The F controls option has indicator light only.

Compressor Current Sensor - The compressor current sensor indicates when the compressor is operational by measuring Amp draw. It is located inside the unit control panel. Relay contacts (NO) are provided to indicate the compressor is not operating.

/////// CABINET AND CLEARANCE DIMENSIONS - WH UNITS

CLEARANCES REQUIRED FOR SERVICE ACCESS AND ADEQUATE CONDENSER INLET AIRFLOW

MODELS	LEFT SIDE	RIGHT SIDE
J18HB, J24HB, J30HB, J36HB	15"	20"

NOTE: For side-by-side installation of two (2) WA models, there must be 20" between units. This can be reduced to 15" by using a WL model (left side compressor and controls) for the left unit and WA (right side compressor and controls) for right unit.

MINIMUM CLEARANCES REQUIRED TO COMBUSTIBLE MATERIALS

MODELS ①	SUPPLY AIR DUCT FIRST THREE FEET	CABINET
J18HB, J24HB	0"	0"
J30HB, J36HB	1/4"	0"

① Refer to the Installation Manual for more detailed information.

DIMENSIONS OF W18HB-36HB BASIC UNIT FOR ARCHITECTURAL & INSTALLATION REQUIREMENTS (NOMINAL)

MODEL	WIDTH (W)	DEPTH (D)	HEIGHT (H)	SUPPLY		RETURN																
				A	B	C	B	E	F	G	I	J	K	L	M	N	O	P	Q	R	S	T
J18HB J24HB	33.300	17.125	74.563	7.88	19.88	11.88	19.88	35.00	10.88	29.75	20.56	30.75	32.06	33.25	31.00	2.63	34.13	26.06	10.55	4.19	12.00	9.00
J30HB J36HB	38.200	17.125	74.563	7.88	27.88	13.88	27.88	40.00	10.88	29.75	17.93	30.75	32.75	33.25	31.00	2.75	39.13	26.75	9.14	4.19	12.00	9.00

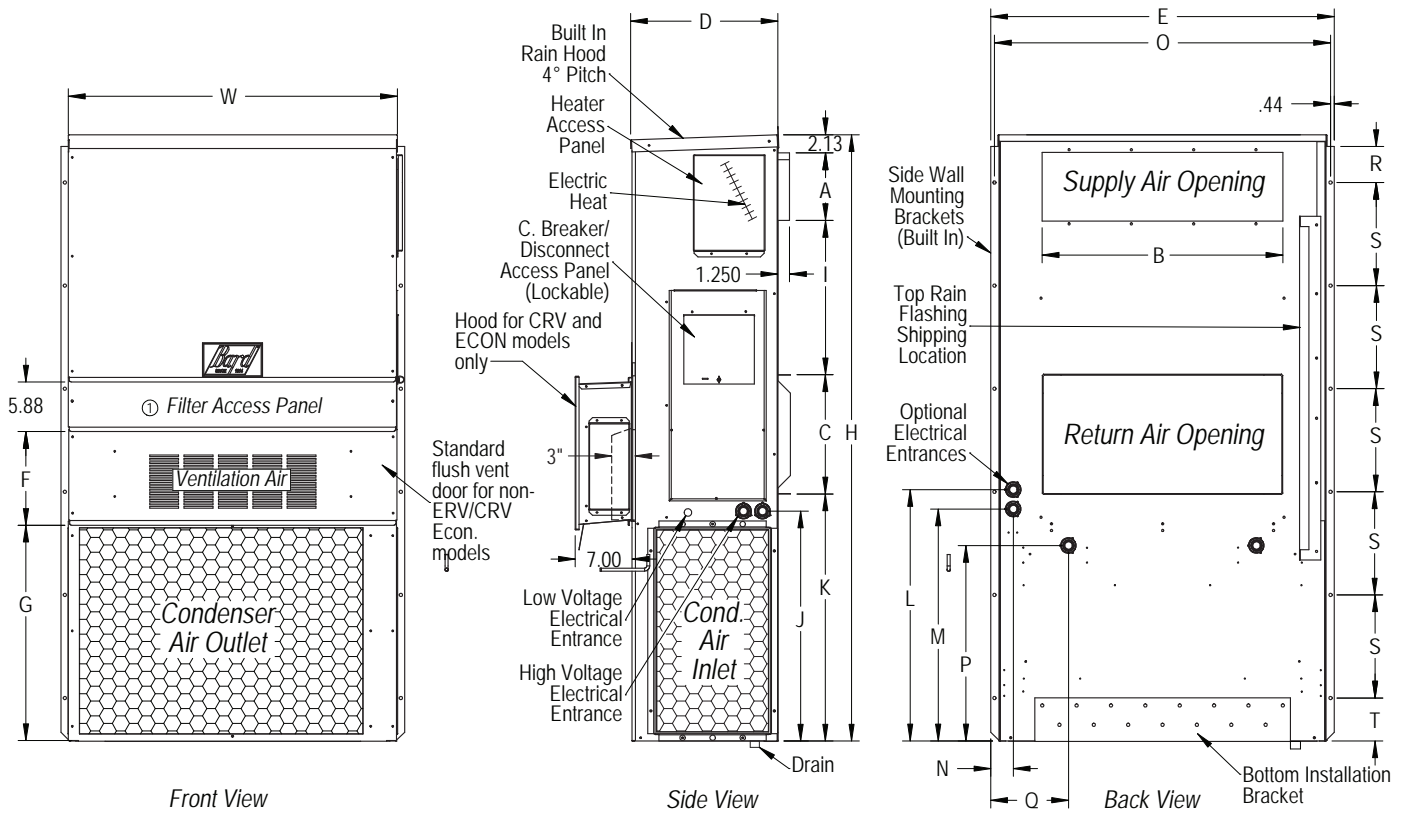

MIS-3796

//////// WALL CURB ACCESSORIES

Optional wall curb accessories are available to help reduce vibration through the outer wall surface or to use existing wall openings when replacing equipment. Follow all static pressure airflow requirements, safety and installation guidelines in the instructions provided with the curb and WALL MOUNT products.

CURB	UNITS USING CURB	DESCRIPTION
WMICF2-*	J18H, J24H	Provides vibration isolation for reduced sound transmission through wall
WMICF3-*	J30H, J36H	Provides vibration isolation for reduced sound transmission through wall
WWC3-*	J30H, J36H	Install to use with existing wall openings. Wall openings must provide sufficient airflow

* Color Option

//////// INDOOR SOUND REDUCTION ACCESSORIES

Optional sound accessories are available to help reduce sound transmission from the supply and return openings inside the indoor area. Follow all static pressure airflow requirements, safety and installation guidelines in the instructions provided with the accessories and WALL MOUNT products.

ACCESSORY	UNITS USING ACCESS.	DESCRIPTION
WAPR11-*	J18H, J24H, J30H, J36H	Acoustical return air plenum that offsets the return air path. Air intake at floor level.

* Color Option

//////// NON-DUCTED SUPPLY AND RETURN GRILLES

Supply and return louver grilles are of a brushed aluminum finish. 2" flange versions are recommended for standard installations to allow grille attachment when large wall openings are present. Return filter grilles are available for filter access from an indoor area. Filter grilles do not include a filter, and are not recommended for unit with ventilation due to filter location. A manual damper return grille is available for W30 and W36 models. The manual damper is adjustable, and is only recommended for installations where increased return duct static pressure is required.

GRILLE NO.	UNITS USING GRILLE	DESCRIPTION OF LOUVER GRILLE
SG-2W	J18H, J24H	8" x 20" with 2" Flange 4 way deflection supply grille. Use for standard installations
SG-3W	J30H, J36H	8" x 28" with 1" Flange 4 way deflection supply grille. Use for standard installations
RG-2W	J18H, J24H	12" x 20" with 2" Flange return grille. Use for standard installations.
RG-3W	J30H, J36H	12" x 28" with 2" Flange return grille. Use for standard installations.
RFG-2W	J18H, J24H	12" x 20" with 2" Flange return grille with filter bracket.
RFG-3W	J30H, J36H	12" x 28" with 2" Flange return grille with filter bracket.
RGD-3	J30H, J36H	12" x 28" with 1" Flange return grille. Manual damper used to restrict return air.

////// NON-DUCTED SUPPLY GRILLES - SPREAD AND THROW CHARACTERISTICS

One of the most important setup procedures for non-ducted supply applications is to adjust the 4 way supply grille blade positions. Placement of equipment, occupants, the thermostat, and room size can all play an important role in deciding how the conditioned supply air must be directed in an indoor area. The chart below may be used as a reference tool to help with this process.

SUPPLY GRILLE	AIRFLOW CFM	DEFLECTION	VELOCITY	TOTAL PRESSURE	THROW
SG-2W	800 CFM	0°	1053	.076" WC	37-52 ft.
		22.5°	1143	.1" WC	28-40 ft.
		45°	1428	.162" WC	20-29 ft.
	865 CFM	0°	1138	.054" WC	40-55 ft.
		22.5°	1236	.075" WC	31-42 ft.
		45°	1544	.113" WC	21-30 ft.
SG-3W	885 CFM	0°	852	.054" WC	37-54 ft.
		22.5°	1075	.075" WC	35-49 ft.
		45°	1162	.113" WC	21-30 ft.
	1285 CFM	0°	1237	.108" WC	42-66 ft.
		22.5°	1359	.147" WC	35-50 ft.
		45°	1687	.249" WC	25-37 ft.

////// CONTROLLER, THERMOSTAT, HUMIDISTAT AND CO2 VENTILATION CONTROL OPTIONS

Bard provides a wide variety of controllers for equipment cooling, thermostats, for equipment and comfort cooling, humidistats for dehumidification units, and CO2 sensors for ventilation control. Lockable thermostat covers are available for applications where security or supervisory control is desired.

CONTROLLER	OPERATION	DESCRIPTION
MC-4002	2 Unit Lead/Lag Controller	Standard Lead/Lag Controller with remote alarming capability.

THERMOSTAT	OPERATION	DESCRIPTION
8403-057	1 Heat/1 Cool	Easy to use, Nonprogrammable
8403-059	2 Heat/2 Cool	Programmable or Nonprogrammable
8403-060	3 Heat/3 Cool	Programmable or Nonprogrammable, ventilation output, dehumidification operation
8403-089	1 Heat/1 Cool	Temp. Settings per Day 4, 2, 1, 0 Programs per Week 7, 5-2, 5-1-1 or Nonprogrammable
8403-090	2 Heat/2 Cool	Temp. Settings per Day 4, 2, 1, 0 Programs per Week 7, 5-2, 5-1-1 or Nonprogrammable
8403-092	2 Heat/2 Cool	Programmable or Nonprogrammable, ventilation output, Wi-Fi

HUMIDISTAT	OPERATION	DESCRIPTION
8403-038	Humidity %RH	Easy to use w/SPDT switching. Ratings: Pilot duty 50VA @24V, 120VA @ 120/240V
8403-047	Humidity %RH	Electronic with display, EEPROM memory, lockable keypad, humidity sensor calibration

CO2 CONTROL	OPERATION	DESCRIPTION
S8403-067	CO2 PPM	CO2 ventilation control with digital display. On/Off or modulating ventilation operation

THERMOSTAT COVER*	SIZE	DESCRIPTION
8405-003	(Inside) 5-1/16" H x 6-1/16" W (Outside) 6-1/2" H x 7-1/2" W x 2-15/16" D	Clear acrylic with ventilation. Fits all thermostats except 8403-060
8405-005	(Inside) 5-7/8" H x 8-3/8" W (Outside) 7-1/4" H x 9-3/4" W x 3-3/8" D	Clear acrylic with ventilation. Fits all thermostats.
8405-006	(Inside) 5-1/16" H x 6-1/16" W (Outside) 6-3/8" H x 7-3/8" W x 2-7/8" D	Beige painted steel cover with ventilation. Fits all thermostats except 8403-060
8405-007	(Inside) 5-7/8" H x 8-3/8" W (Outside) 7-1/8" H x 9-5/8" W x 3-1/4" D	Beige painted steel cover with ventilation. Fits all thermostats.

* Thermostat covers include ventilation, but may effect temperature control reaction time. If security control lockout is needed, the 8403-060 thermostat provides input control lockout features.



Bard Manufacturing Company, Inc.
1914 Randolph Dr., Bryan, OH 43506
419-636-1194

www.bardhvac.com

Due to our continuous product improvement policy, all specifications subject to change without notice.

Before purchasing this appliance, read important energy cost and efficiency information available from your retailer.